

Străile cu interes de ora?  
 Profile transversale ale str. MăreCalea  
 B?i?ului, Coșu?ului, str. Stroescu, nr. 7, nr. 8, nr. 10,  
 str. Bujorului, str. doct. D. Gh. Volunilor – sect. drum cu  
 interes de ora, Decebal, Olhonia, Rena?terii, D. Cantemir,  
 str. Rurala, str. N. Testemiteanu, str. Măoșii, str. M. Costin

M 1:200

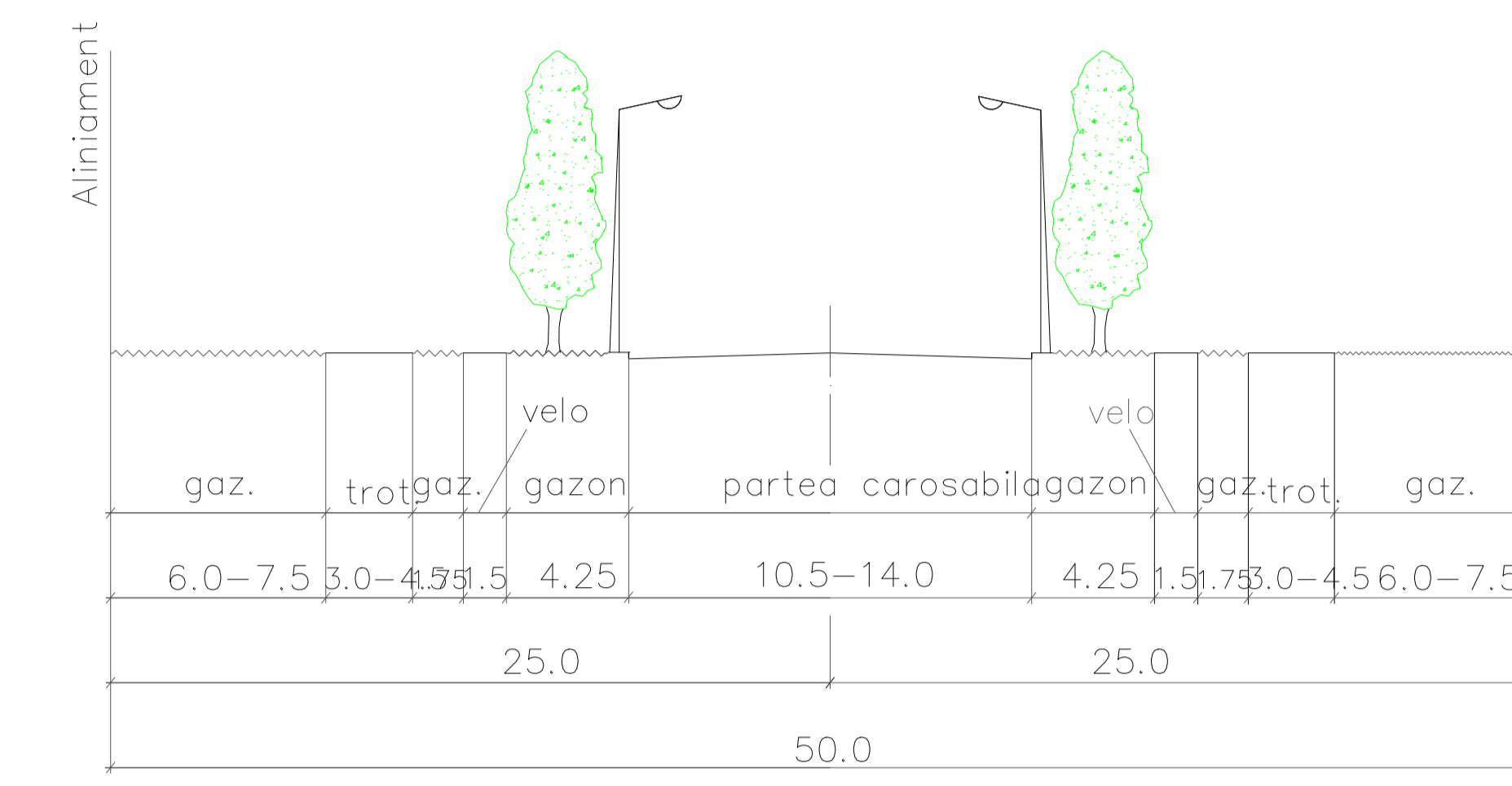

str. Artelor

M 1:200

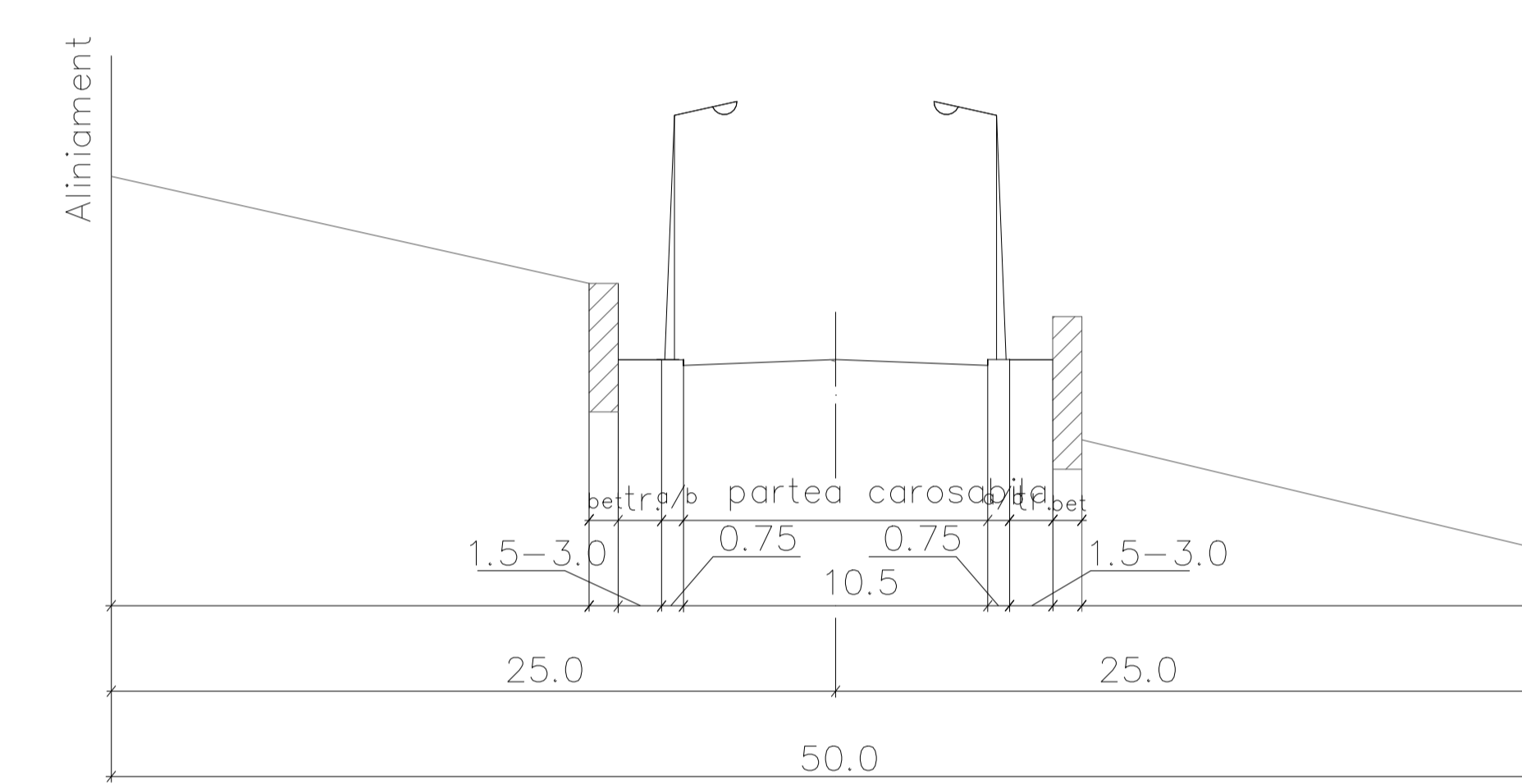

LEGENDA

- LIMITA HOTARULUI EXISTENT
- LIMITA HOTARULUI PROPU
- LIMITA RAIONELOR
- SUPRAFETE ADVATICE
- SPATII VERZI, PARCURI SI TERENURI SPORTIVE
- ZONA GOSPODRIEI COMUNALE SI CIMIRE
- CIMIRE CU INMORMINTARE STOPATA
- ZONA LOCUINTELOR INDIVIDUALE IN REGIM MIC DE INTINSE EXISTENT
- ZONA BLOCURILOR LOCATIVE MULTIETAJATE CU APARTAMENTE COLECTIVE EXISTENTE
- TERITRII PROPUSE PENTRU DEZVOLTAREA ORASULUI IN PERSPECTIV?
- ZONA OBIECTELOR DE UTILITATE PUBLICE EXISTENTE
- ZONA DE PRODUCERE INDUSTRIAL? SI AGRICOL?
- ZONA CU DESINATIE SPECIAL?
- AUTOMAGISTRAL?
- STRAD? PRINCIPALA CU INTERES DE ORA?
- STRAD? PRINCIPALA CU INTERES DE RAION
- STRAD? -PEA
- SPALATORIE AUTOEXISTENTE
- SPALATORIE AUTOPROPUSE
- GARAJE
- STADI DE ALIMENTARE EXISTENTE
- STADI DE DESERVIRE TEHNICE EXISTENTE
- CARA AUTO de INTERES @ (existent)
- CARA AUTOPUBLICAN (propusa)

Magistrala Sculeni-Soroca-fr.Ucraina  
 (in zona ora?ului)  
 M 1:200

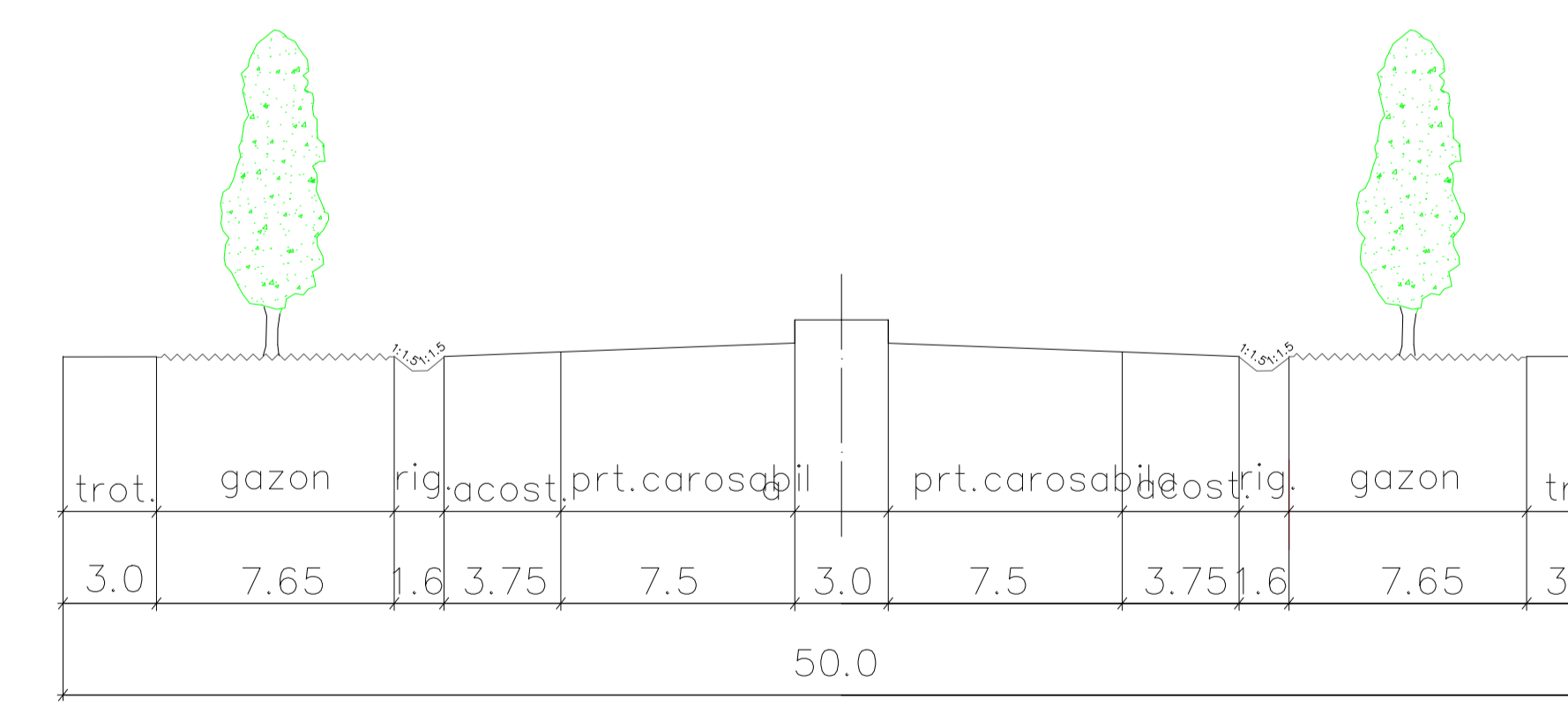

Străile cu interes de raion  
 Profile transversale al str.nr.1,nr.3,nr.4,nr.5,nr.6,nr.11,  
 str.Zorilor,str.Volunilor – sect. drum cu interes de raion, Profile transversale al  
 str.Independen?i str.Alexandru cel Bun  
 M 1:200

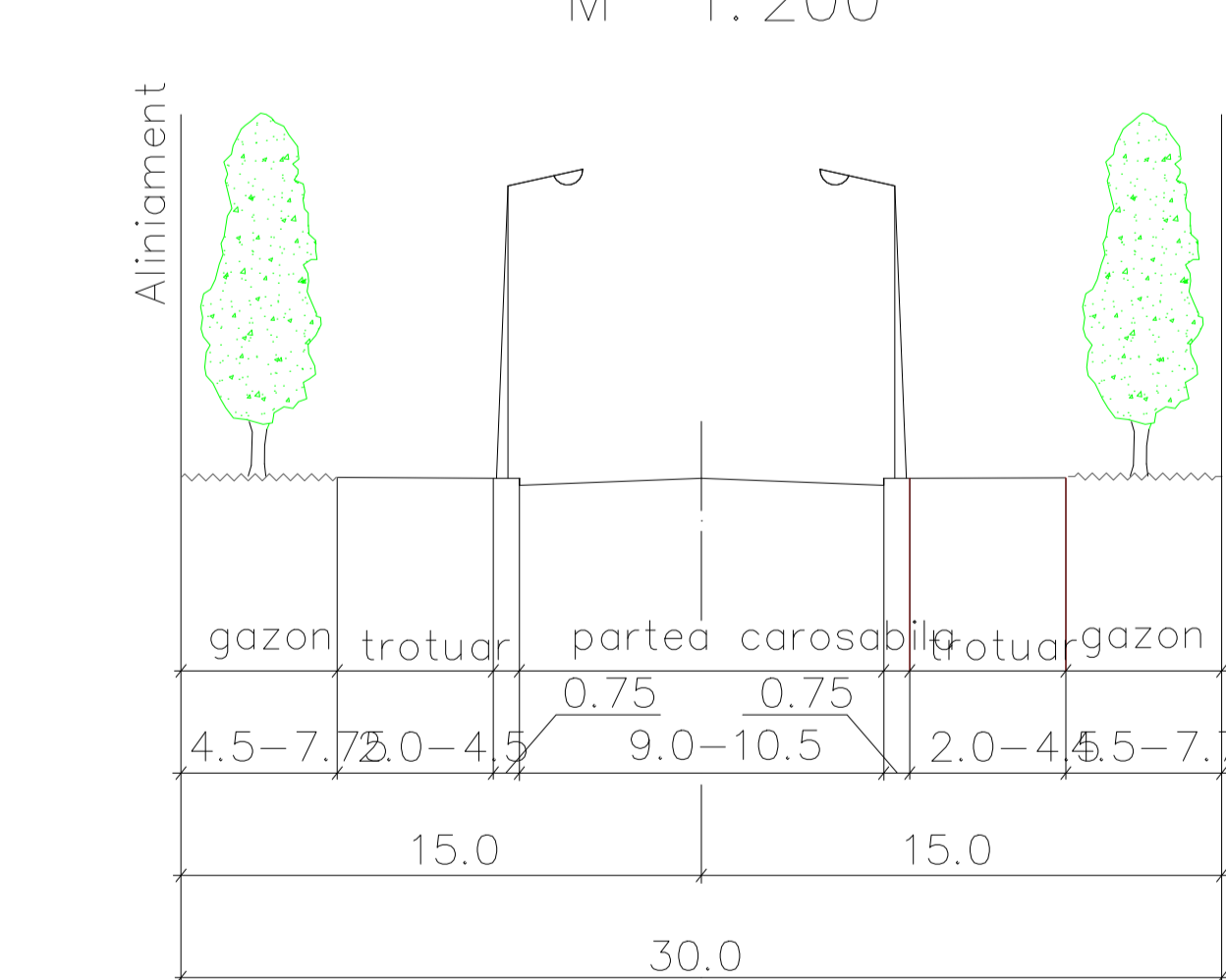
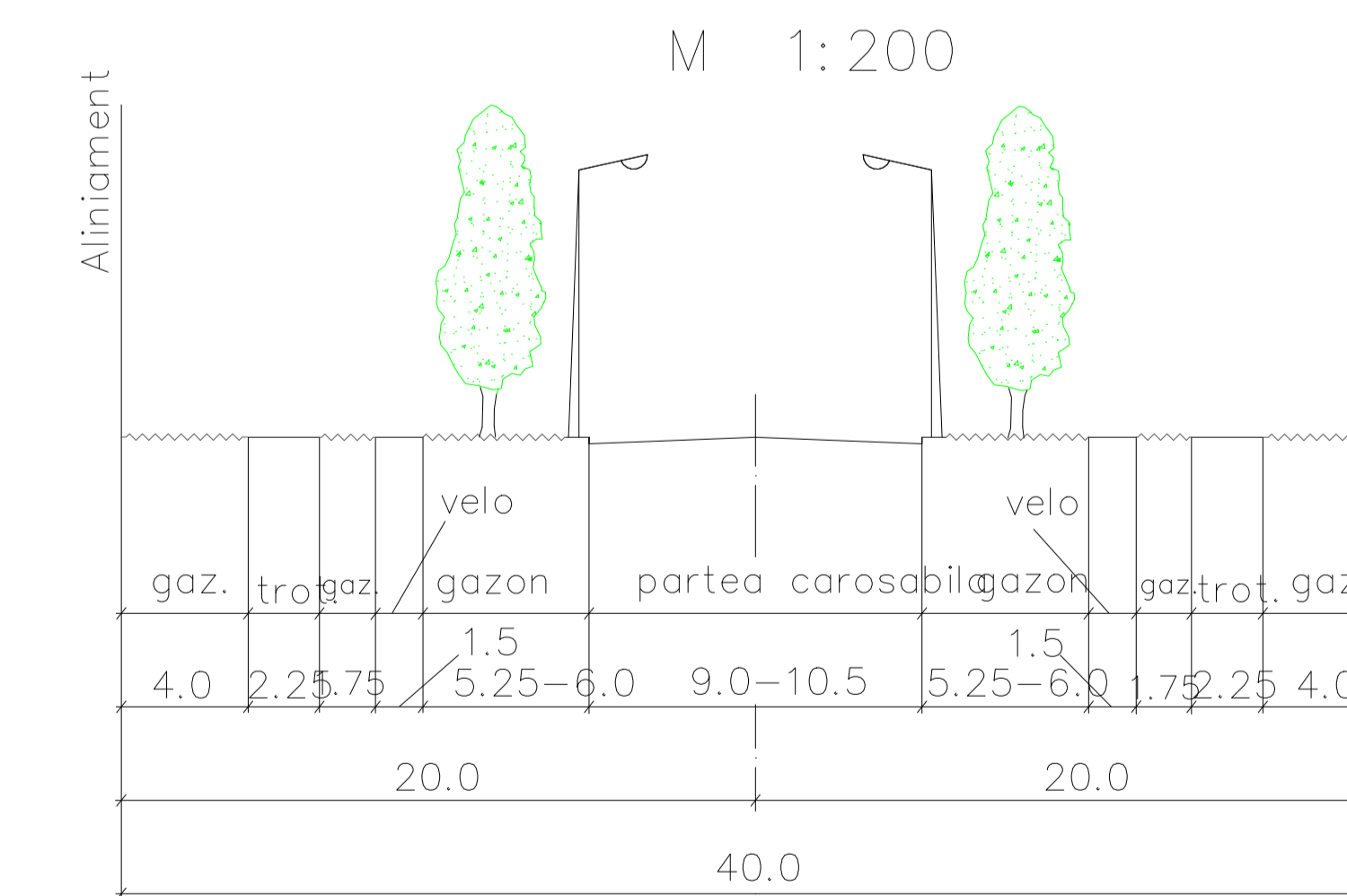

Drumul Na?ional M2,R7,R9  
 M 1:200

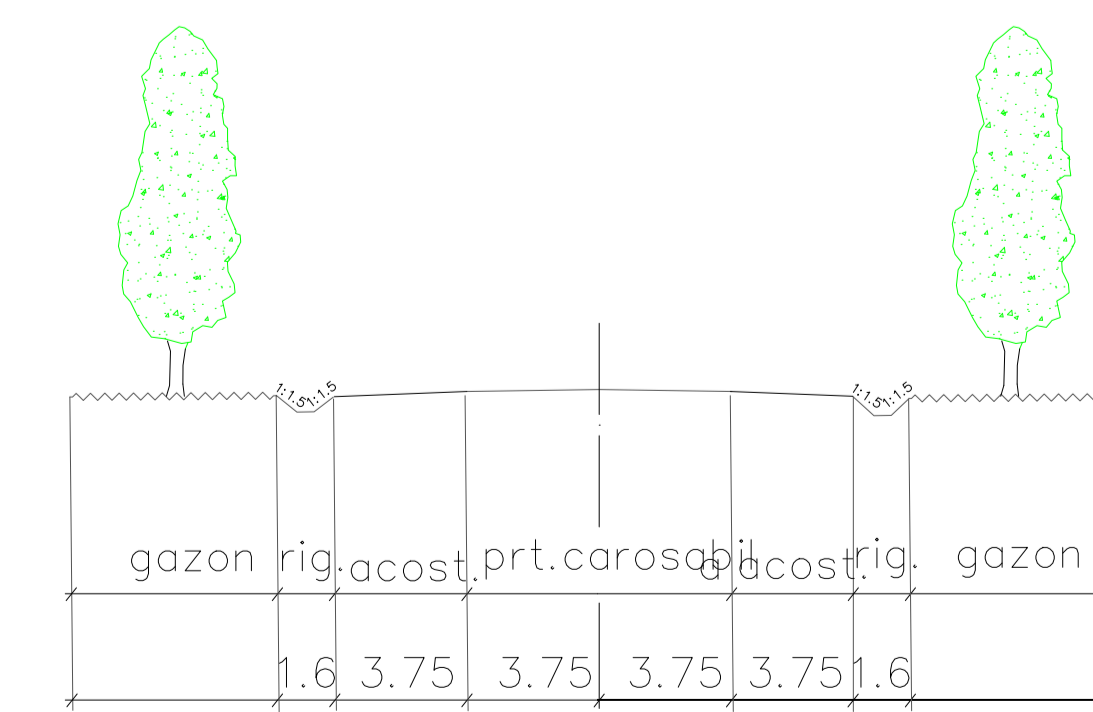

Trecere  
 M 1:200

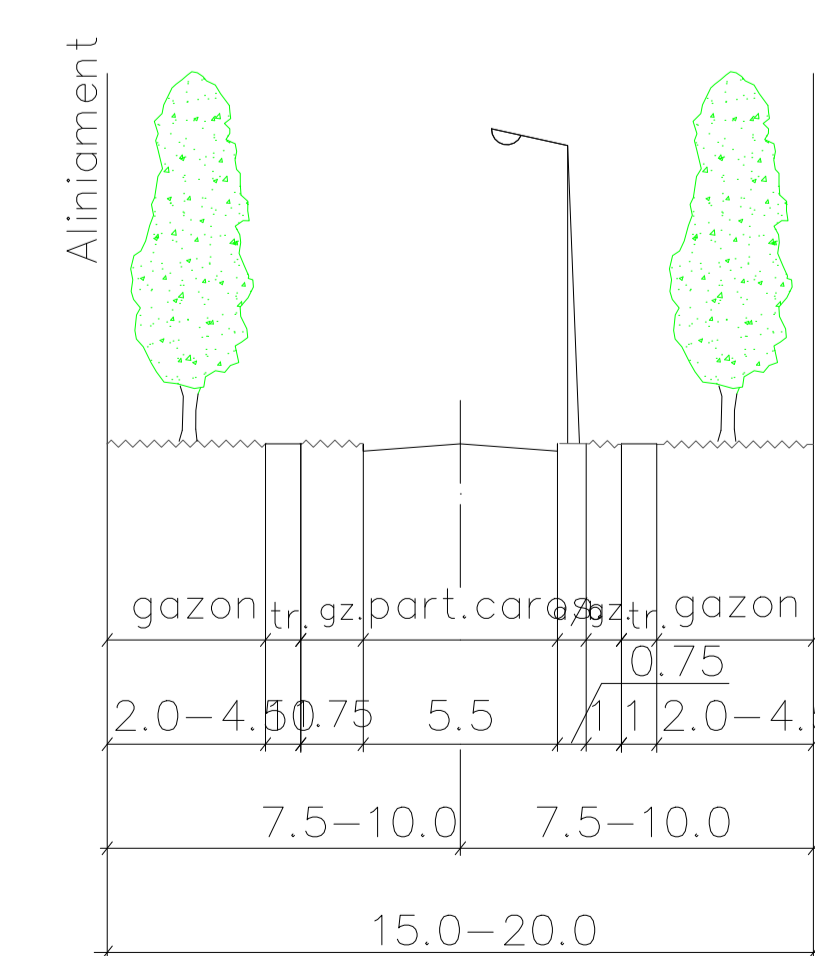

Beneficiar Primăria or. Soroca	Scara 1:500	2011	1:1.5.000
Proiectant INCF	PLANULUI URBANISTIC GENERAL al orașului SOROCA	ETAPA	DETAIATA PLANULUI
Proiectant INCF	RELEAUA DE STRAD? SI DRUMURI SI DE COMUNICATI SI TRANSPORT URBANISTICE	NOI	INCF
Proiectant INCF	RELEAUA DE STRAD? SI DRUMURI SI DE COMUNICATI SI TRANSPORT URBANISTICE	NOI	INCF